

DIMENSIONS FOR OVERALL HEIGHT AND LENGTH ARE APPROXIMATE  
 OVERALL HEIGHT = 102.5"  
 OVERALL WIDTH WITH RUB  
 RAILS & FENDERETTES = 95"

(7) WHELEN 600 SUPER LED WITH CLEAR LENSES  
 RED / RED / RED / WHITE / RED / RED / RED

(5) TECNIQ S330 AMBER  
 MINI-LED MARKER LIGHTS

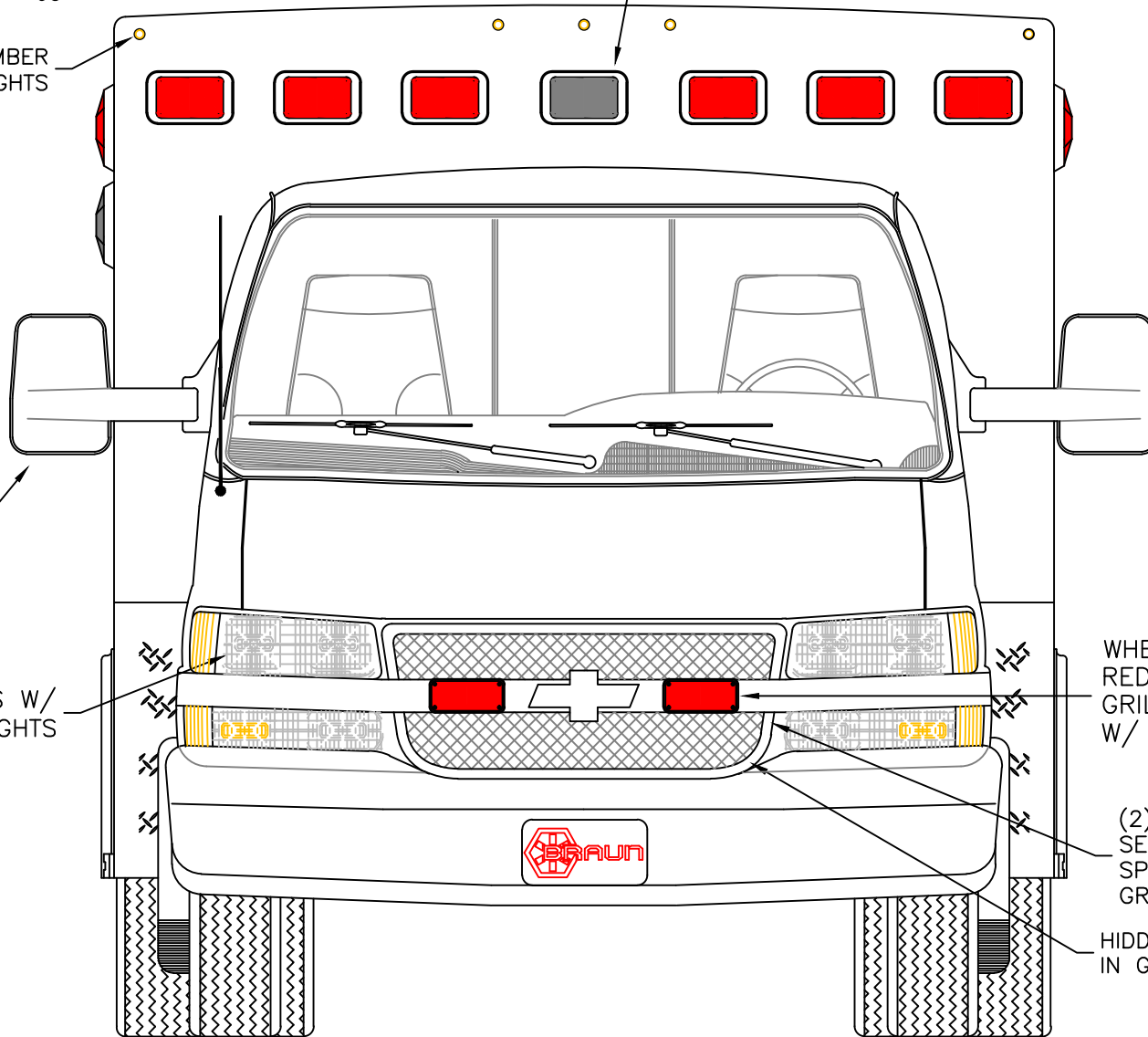

VELVAC 2020XG  
 HEATED/REMOTE  
 MIRRORS

FLASHING HEADLIGHTS W/  
 DAYTIME RUNNING LIGHTS

WHELEN 700 SERIES  
 RED SUPER LED  
 GRILLE LIGHTS  
 W/ CLEAR LENSES

(2) WHELEN SA315  
 SERIES SIREN  
 SPEAKERS BEHIND  
 GRILLE AREA

HIDDEN UNLOCK SWITCH  
 IN GRILLE AREA

THIS DRAWING IS FOR REPRESENTATIONAL PURPOSES ONLY. DETAILS ARE CONCEPTUAL AND ARE SUBJECT TO CHANGE DURING DESIGN AND CONSTRUCTION  
 DIMENSIONS ARE APPROXIMATE UNLESS NOTED OTHERWISE TO MEET A SPECIFIC CUSTOMER NEED.

BRAUN  
 SIGNATURE SERIES



2020 FRONT EXTERIOR VIEW  
 SIGNATURE SERIES / CHEVY G3500 GAS CHASSIS

DATE:  
 02-14-20

DRAWING NO.

DWG. AAB  
 REV. NR

SIGNATURE-1

APPROVAL SIGNATURE:

DATE:

DIMENSIONS FOR OVERALL HEIGHT AND LENGTH ARE APPROXIMATE  
 OVERALL HEIGHT = 102.5"  
 OVERALL WIDTH WITH RUB  
 RAILS & FENDERETTES = 95"

(5) WHELEN 600 SUPER LED WARNING LIGHTS WITH CLEAR LENSES,  
 (2) WHELEN 600 CLEAR LED LOAD LIGHTS:  
 RED / RED / LOAD / AMBER / LOAD / RED / RED

(5) TECNIQ S330 RED  
 MINI-LED MARKER LIGHTS

(2) WHELEN 900 RED  
 SUPER LED LIGHTS  
 WITH CLEAR LENSES

LOCATION FOR  
 DOOR GRABBERS

(1) EACH SIDE, WHELEN  
 600 LED BRAKE/TAIL,  
 600 LED TURN  
 600 LED BACK-UP

LED LICENSE  
 PLATE LIGHT

MUD FLAPS

INDEPENDENT BUMPER WITH  
 NON-SKID FLIP-UP CENTER  
 STEP AND COT PROTECTOR  
 ON STEP EDGE.

THIS DRAWING IS FOR REPRESENTATIONAL PURPOSES ONLY. DETAILS ARE CONCEPTUAL AND ARE SUBJECT TO CHANGE DURING DESIGN AND CONSTRUCTION  
 DIMENSIONS ARE APPROXIMATE UNLESS NOTED OTHERWISE TO MEET A SPECIFIC CUSTOMER NEED.

BRAUN  
 SIGNATURE SERIES



2020 REAR EXTERIOR VIEW  
 SIGNATURE SERIES

DATE: 02-14-20	DWG. AAB	REV. NR
-------------------	-------------	------------

DRAWING NO.  
SIGNATURE-2

DIMENSIONS FOR OVERALL HEIGHT AND LENGTH ARE APPROXIMATE  
 OVERALL HEIGHT = 102.5"  
 OVERALL LENGTH = 260"  
 MODULE LENGTH = 150"

TECNIQ S330 RED MINI-LED MARKER LIGHT TO ALSO FLASH WITH TURN SIGNAL

(2) WHELEN 900 RED SUPER LED WARNING LIGHTS WITH CLEAR LENSES

(2) WHELEN 900 24-DIODE LED SCENE LIGHTS

KUSSMAUL 20AMP AUTO-EJECT SHORELINE INLET

WHELEN 700 RED LED WITH CLEAR LENS

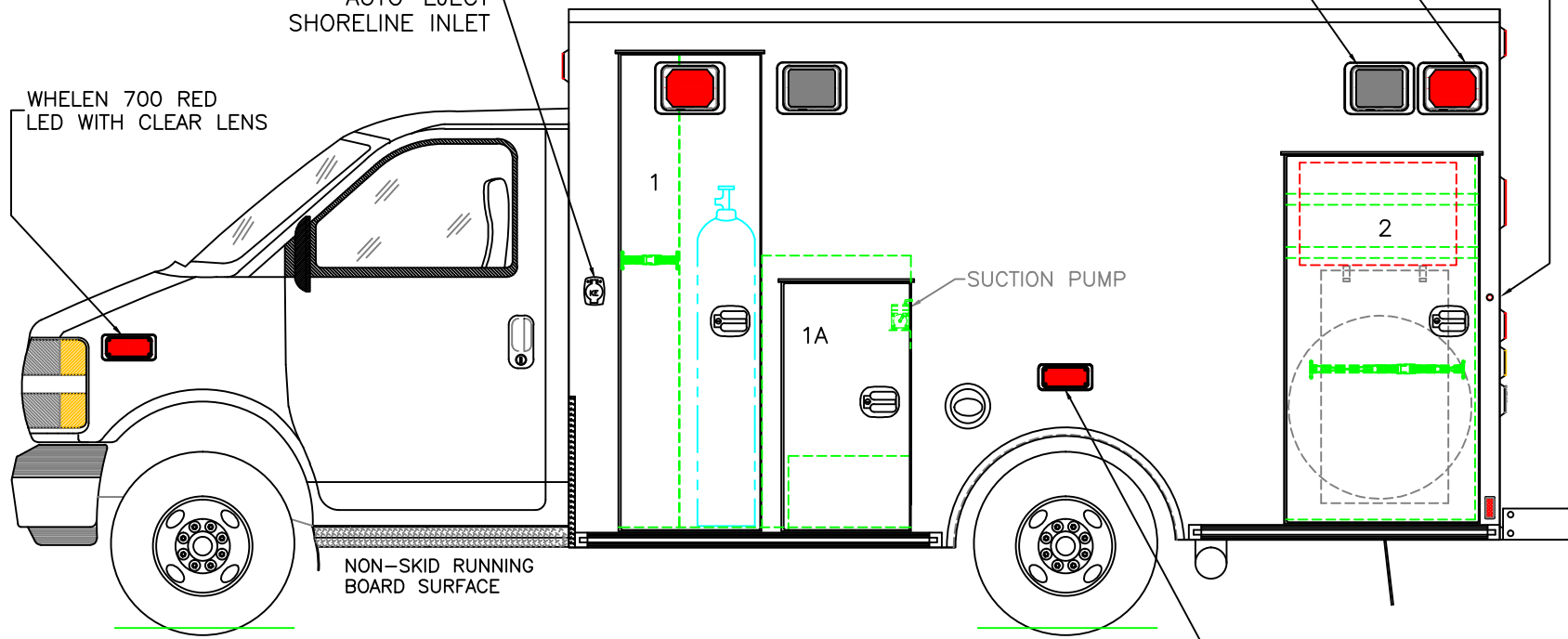

COMPARTMENT  
 O.S.S #1

CLEAR OPENING: 75.00h x 19.25w  
 INSIDE DIMS: 76.25h x 22.75w x 18.50d  
 OXYGEN STORAGE ON RIGHT SIDE OF VERTICAL DIVIDER  
 DIVIDER DEPTH = 8" TO ALLOW ALTERNATE STAIR  
 CHAIR STORAGE OUTBOARD OF OXYGEN  
 (1) STRAP ON LEFT SIDE OF DIVIDER  
 OXYGEN BRACKET & DIVIDER TO BE BOLT-IN  
 OSS & DOOR PREPPED TO HOLD THE EZ-O2 LIFT

O.S.S #1A

CLEAR OPENING: 38.75h x 17.50w  
 INSIDE DIM'S.: 43.75h x 24.00w x 18.50d

O.S.S #2

CLEAR OPENING: 57.75h x 28.00w  
 INSIDE DIM'S.: 59.50h x 31.25w x 18.50d  
 INSIDE/OUTSIDE ACCESS  
 (2) ADJUSTABLE SHELVES: UPPER=FULL DEPTH; LOWER=REDUCED DEPTH DUE TO STAIR CHAIR ON INSIDE OF DOOR  
 MOUNTING HOOKS AND STRAP ON INSIDE OF DOOR FOR STRYKER 6252 OR FERNO EZ-GLIDE STAIR CHAIR  
 OPTIONAL SPARE TIRE STORAGE (MOUNT NOT INCLUDED AS STANDARD)  
 NOTE: STAIR CHAIR AND SPARE STORAGE WILL NOT FIT AT SAME TIME

THIS DRAWING IS FOR REPRESENTATIONAL PURPOSES ONLY. DETAILS ARE CONCEPTUAL AND ARE SUBJECT TO CHANGE DURING DESIGN AND CONSTRUCTION  
 DIMENSIONS ARE APPROXIMATE UNLESS NOTED OTHERWISE TO MEET A SPECIFIC CUSTOMER NEED.

BRAUN  
 SIGNATURE SERIES



2020 STREETSIDE EXTERIOR VIEW  
 SIGNATURE SERIES / CHEVY G3500 CHASSIS

DATE: 02-14-20  
 DWG. AAB REV. NR

DRAWING NO. SIGNATURE-3

DIMENSIONS FOR OVERALL HEIGHT AND LENGTH ARE APPROXIMATE  
 OVERALL HEIGHT = 102.5"  
 OVERALL LENGTH = 260"  
 MODULE LENGTH = 150"

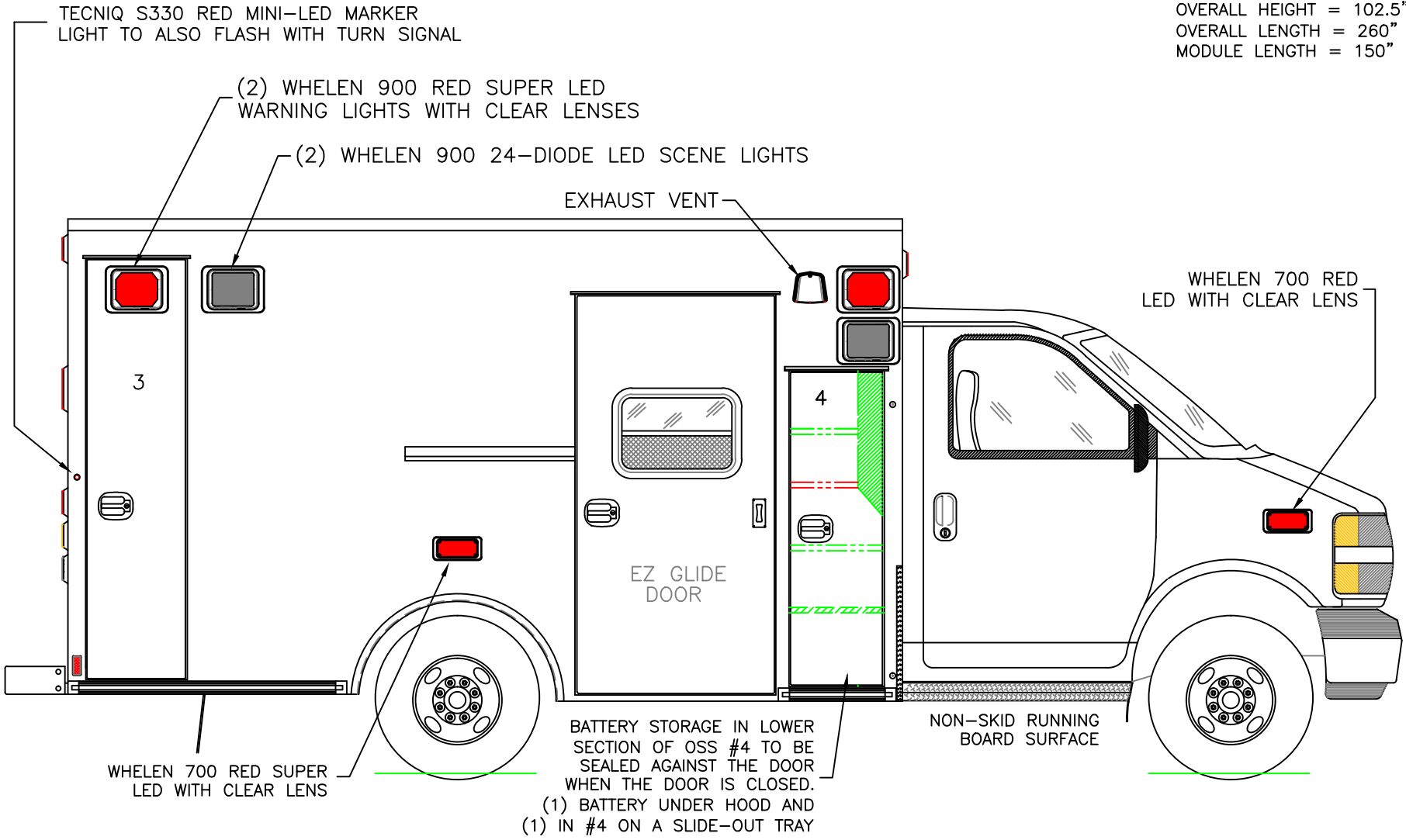

O.S.S #3  
 CLEAR OPENING: 73.75h x 15.00w  
 INSIDE DIM'S.: 75.00h x 18.00w x 18.50d  
 BACKBOARD/SCOOP STORAGE

O.S.S #4  
 CLEAR OPENING: 54.75h x 15.50w  
 INSIDE DIM'S.: SEE PARTITION INTERIOR VIEW  
 INSIDE/OUTSIDE ACCESS

THIS DRAWING IS FOR REPRESENTATIONAL PURPOSES ONLY. DETAILS ARE CONCEPTUAL AND ARE SUBJECT TO CHANGE DURING DESIGN AND CONSTRUCTION  
 DIMENSIONS ARE APPROXIMATE UNLESS NOTED OTHERWISE TO MEET A SPECIFIC CUSTOMER NEED.

BRAUN  
 SIGNATURE SERIES



2020 CURB EXTERIOR VIEW  
 SIGNATURE SERIES / CHEVY G3500 CHASSIS

DATE:  
 02-14-20  
 DWG. AAB  
 REV. NR

DRAWING NO.  
 SIGNATURE-4

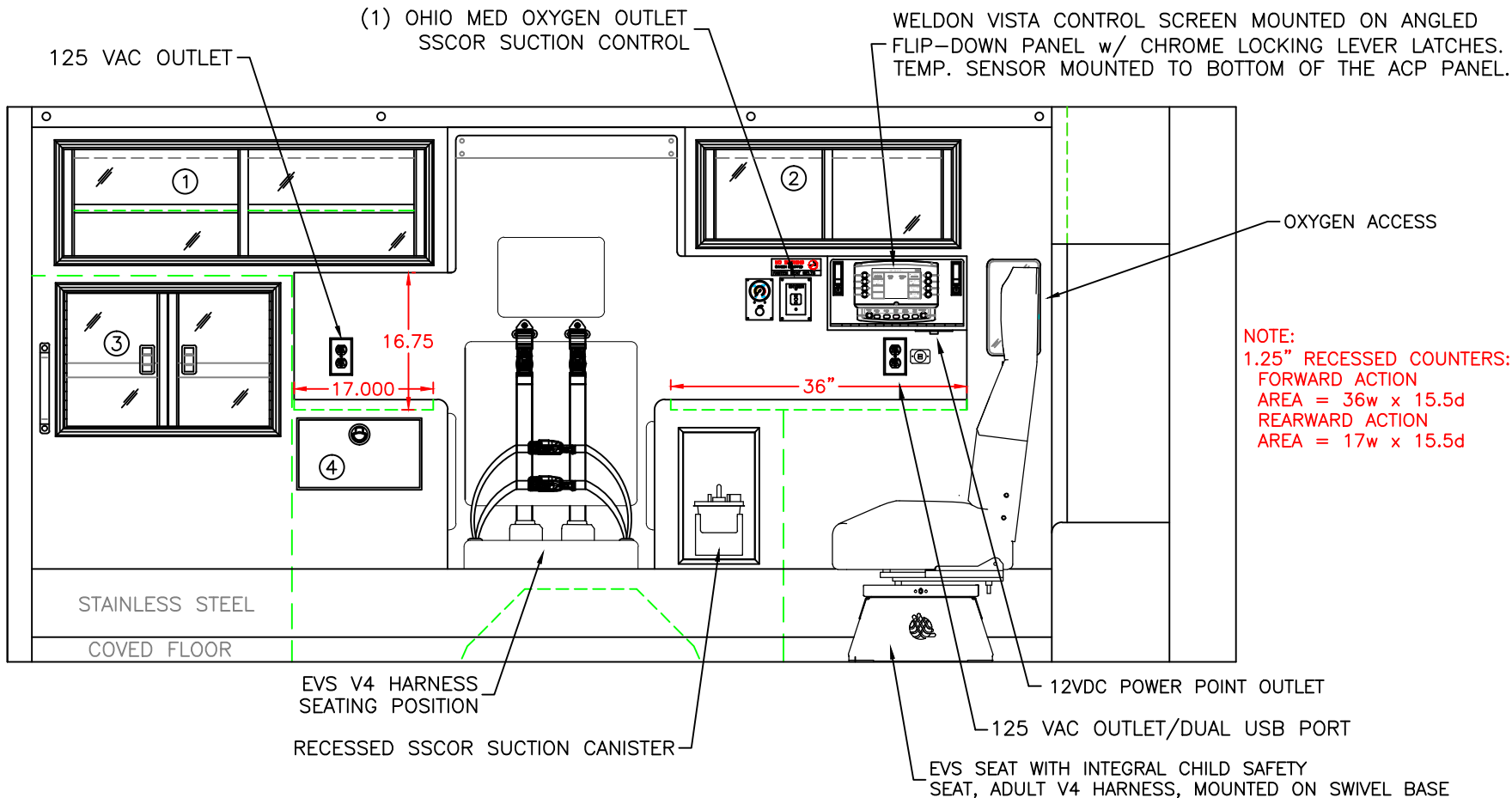

**COMPARTMENT:**

#1 DOOR OPENING: 13.00h x 44.00w  
 INSIDE DIMS: 14.75h x 45.75w x 16.25d  
 (1) ADJUSTABLE SHELF  
 SLIDING POLYCARBONATE DOORS  
 TOTAL CABINET WEIGHT RATING = 25 lbs.

#2 DOOR OPENING: 11.00h x 30.00w  
 INSIDE DIMS: 12.75h x 31.75w x 16.25d  
 SLIDING POLYCARBONATE DOORS  
 TOTAL CABINET WEIGHT RATING = 25 lbs.

#3 DOOR OPENING: 16.50h x 24.50w  
 INSIDE/OUTSIDE COMPARTMENT ACCESS  
 HINGED POLYCARBONATE DOORS WITH FULL LENGTH HANDLES  
 CENTER SQUEEZE LATCHES  
 TOTAL CABINET WEIGHT RATING = 40 lbs.

#4 PULL-OUT DRAWER  
 INSIDE DIMS: 7.00h x 13.25w x 15.75d  
 LOCKING STAINLESS STEEL FLUSH PULL LATCH  
 TOTAL DRAWER WEIGHT RATING = 10 lbs.

CABINETS TO BE ALUMINUM

THIS DRAWING IS FOR REPRESENTATIONAL PURPOSES ONLY. DETAILS ARE CONCEPTUAL AND ARE SUBJECT TO CHANGE DURING DESIGN AND CONSTRUCTION DIMENSIONS ARE APPROXIMATE UNLESS NOTED OTHERWISE TO MEET A SPECIFIC CUSTOMER NEED.

BRAUN  
SIGNATURE SERIES



2020 STREETSIDE INTERIOR  
SIGNATURE SERIES

DATE: 02-14-20	DRAWING NO. SIGNATURE-5 WITH CPR SEAT
DWG. AAB	REV. NR

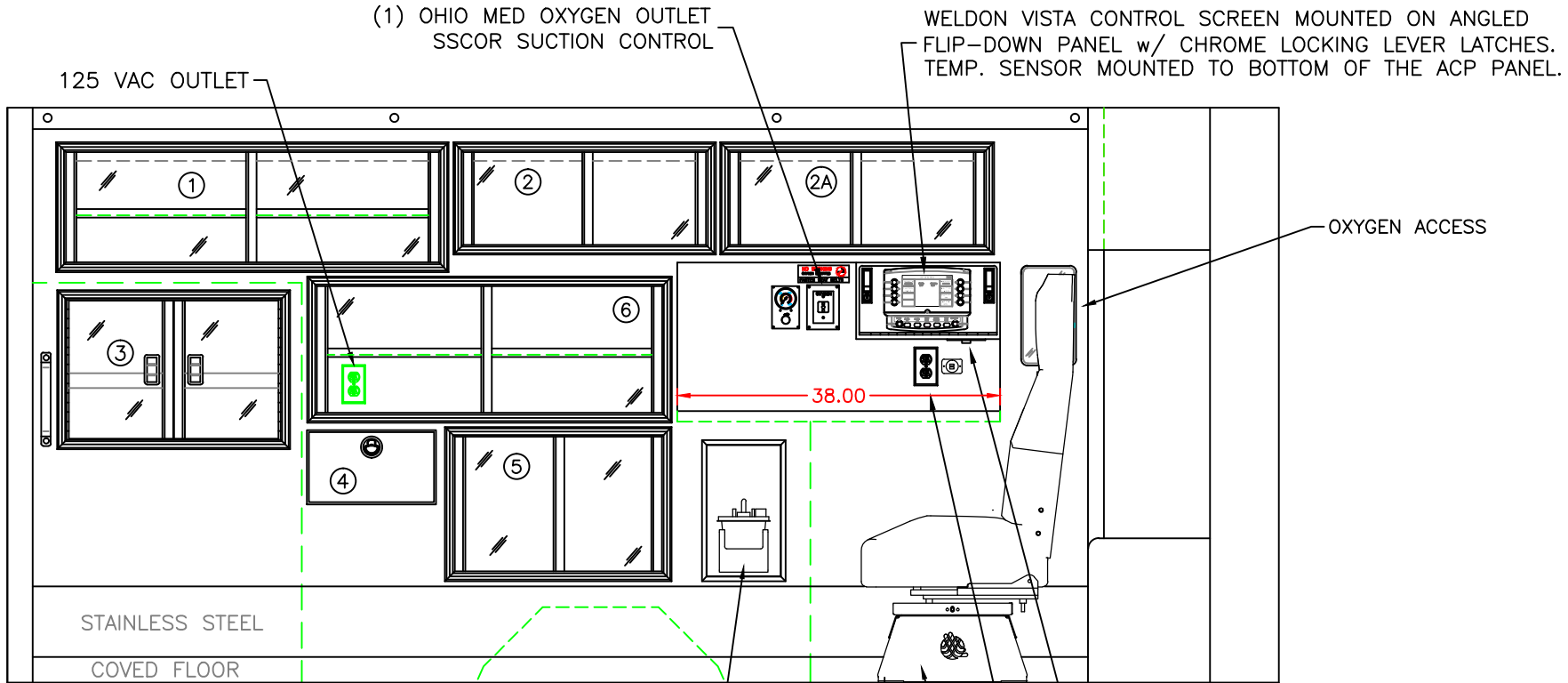

**COMPARTMENT:**

- #1 DOOR OPENING: 13.00h x 44.00w  
 INSIDE DIMS: 14.75h x 45.75w x 16.25d  
 (1) ADJUSTABLE SHELF  
 SLIDING POLYCARBONATE DOORS  
 TOTAL CABINET WEIGHT RATING = 25 lbs.
- #2 DOOR OPENING: 11.00h x 28.50w  
 INSIDE DIMS: 12.75h x 30.25w x 16.25d  
 SLIDING POLYCARBONATE DOORS  
 TOTAL CABINET WEIGHT RATING = 25 lbs.
- #2A DOOR OPENING: 11.00h x 30.00w  
 INSIDE DIMS: 12.75h x 31.75w x 16.25d  
 SLIDING POLYCARBONATE DOORS  
 TOTAL CABINET WEIGHT RATING = 25 lbs.

- #3 DOOR OPENING: 16.50h x 24.50w  
 INSIDE/OUTSIDE COMPARTMENT ACCESS  
 HINGED POLYCARBONATE DOORS WITH FULL LENGTH  
 HANDLES CENTER SQUEEZE LATCHES  
 TOTAL CABINET WEIGHT RATING = 40 lbs.
- #4 PULL-OUT DRAWER  
 INSIDE DIMS: 7.00h x 13.25w x 15.75d  
 LOCKING STAINLESS STEEL FLUSH PULL LATCH  
 TOTAL DRAWER WEIGHT RATING = 10 lbs.
- #5 DOOR OPENING: 15.75h x 24.25w  
 INSIDE DIMS: 17.50h x 26.00w x 16.25d  
 SLIDING POLYCARBONATE DOORS  
 TOTAL CABINET WEIGHT RATING = 25 lbs.

- #6 DOOR OPENING: 15.00h x 40.75w  
 INSIDE DIMS: 16.75h x 42.50w x 16.25d  
 (1) ADJUSTABLE SHELF  
 SLIDING POLYCARBONATE DOORS  
 TOTAL CABINET WEIGHT RATING = 25 lbs.

CABINETS TO BE ALUMINUM

THIS DRAWING IS FOR REPRESENTATIONAL PURPOSES ONLY. DETAILS ARE CONCEPTUAL AND ARE SUBJECT TO CHANGE DURING DESIGN AND CONSTRUCTION DIMENSIONS ARE APPROXIMATE UNLESS NOTED OTHERWISE TO MEET A SPECIFIC CUSTOMER NEED.

(1) OHIO MED OXYGEN OUTLET

(2) EVS V4 HARNESS SEATING POSITIONS. RETRACTORS INSTALLED FOR SECOND PATIENT TRANSPORT.

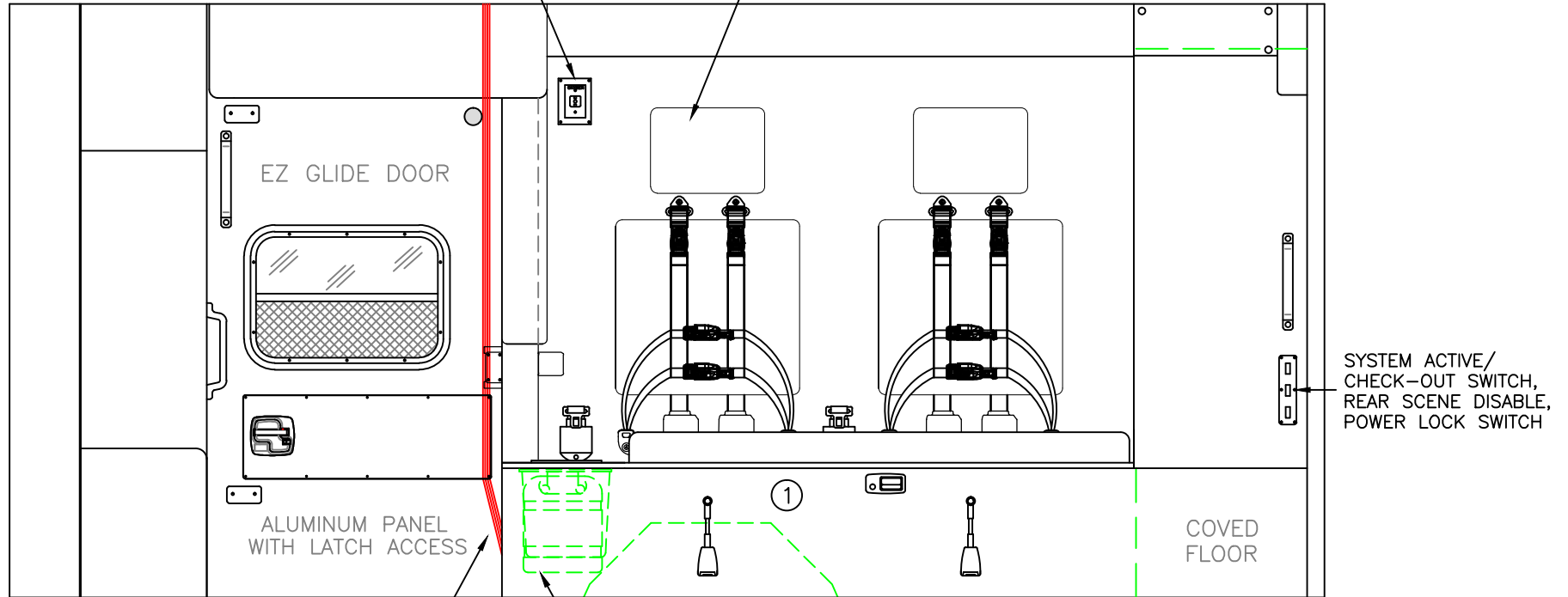

ATTENDANT NET

SHARPS/TRASH DISPOSAL THROUGH HINGED ACRYLIC LID

SYSTEM ACTIVE/  
CHECK-OUT SWITCH,  
REAR SCENE DISABLE,  
POWER LOCK SWITCH

COMPARTMENT

#1 INSIDE DIMS: 15.50h x 72.00w x 18.50d

CABINETS TO BE ALUMINUM

THIS DRAWING IS FOR REPRESENTATIONAL PURPOSES ONLY. DETAILS ARE CONCEPTUAL AND ARE SUBJECT TO CHANGE DURING DESIGN AND CONSTRUCTION DIMENSIONS ARE APPROXIMATE UNLESS NOTED OTHERWISE TO MEET A SPECIFIC CUSTOMER NEED.

BRAUN  
SIGNATURE SERIES



2020 CURBSIDE INTERIOR VIEW  
SIGNATURE SERIES

DATE: 02-14-20	
DWG. AAB	REV. NR

DRAWING NO. SIGNATURE-6
----------------------------

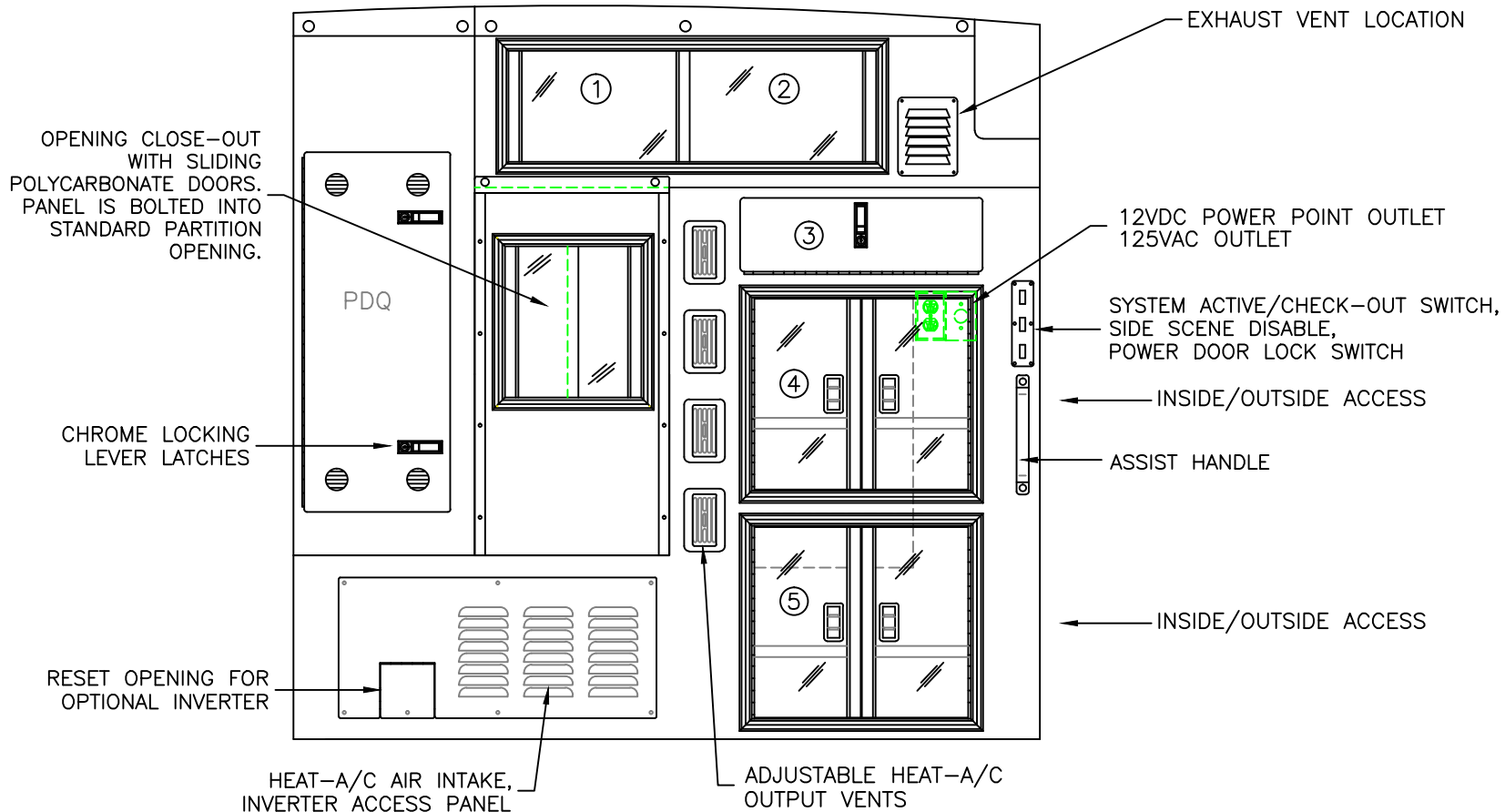

**COMPARTMENT**

#1/#2 DOOR OPENING: 10.25h x 34.00w  
 INSIDE DIMS: 13.25h x 35.75w x 13.25d  
 PERMANENT DIVIDER(CENTERED)  
 SLIDING POLYCARBONATE DOORS  
 TOTAL CABINET WEIGHT RATING = 25 lbs.

#3 DROP-DOWN HINGED ALUMINUM DOOR  
 WITH CHROME LOCKING LEVER LATCH  
 OPENING DIMS: 6.50h x 22.00w  
 INSIDE DIMS: 7.50h x 22.00w x 14.25d  
 TOTAL CABINET WEIGHT RATING = 15 lbs.

#4, #5 DOOR OPENINGS: 17.75h x 20.00w  
 INSIDE DIMS: 19.25h x 28.00w x 13.25d  
 HINGED POLYCARBONATE DOORS WITH FULL LENGTH HANDLES  
 CENTER SQUEEZE LATCHES  
 (1) ADJUSTABLE SHELF PER COMPARTMENT  
 TOTAL CABINET WEIGHT RATING = 60 lbs. EACH

CABINETS TO BE ALUMINUM

THIS DRAWING IS FOR REPRESENTATIONAL PURPOSES ONLY. DETAILS ARE CONCEPTUAL AND ARE SUBJECT TO CHANGE DURING DESIGN AND CONSTRUCTION DIMENSIONS ARE APPROXIMATE UNLESS NOTED OTHERWISE TO MEET A SPECIFIC CUSTOMER NEED.

BRAUN  
SIGNATURE SERIES



2020 PARTITION INTERIOR VIEW  
SIGNATURE SERIES

DATE:  
02-14-20  
DWG. AAB REV. NR

DRAWING NO.  
SIGNATURE-7



ATTENDANT  
NET

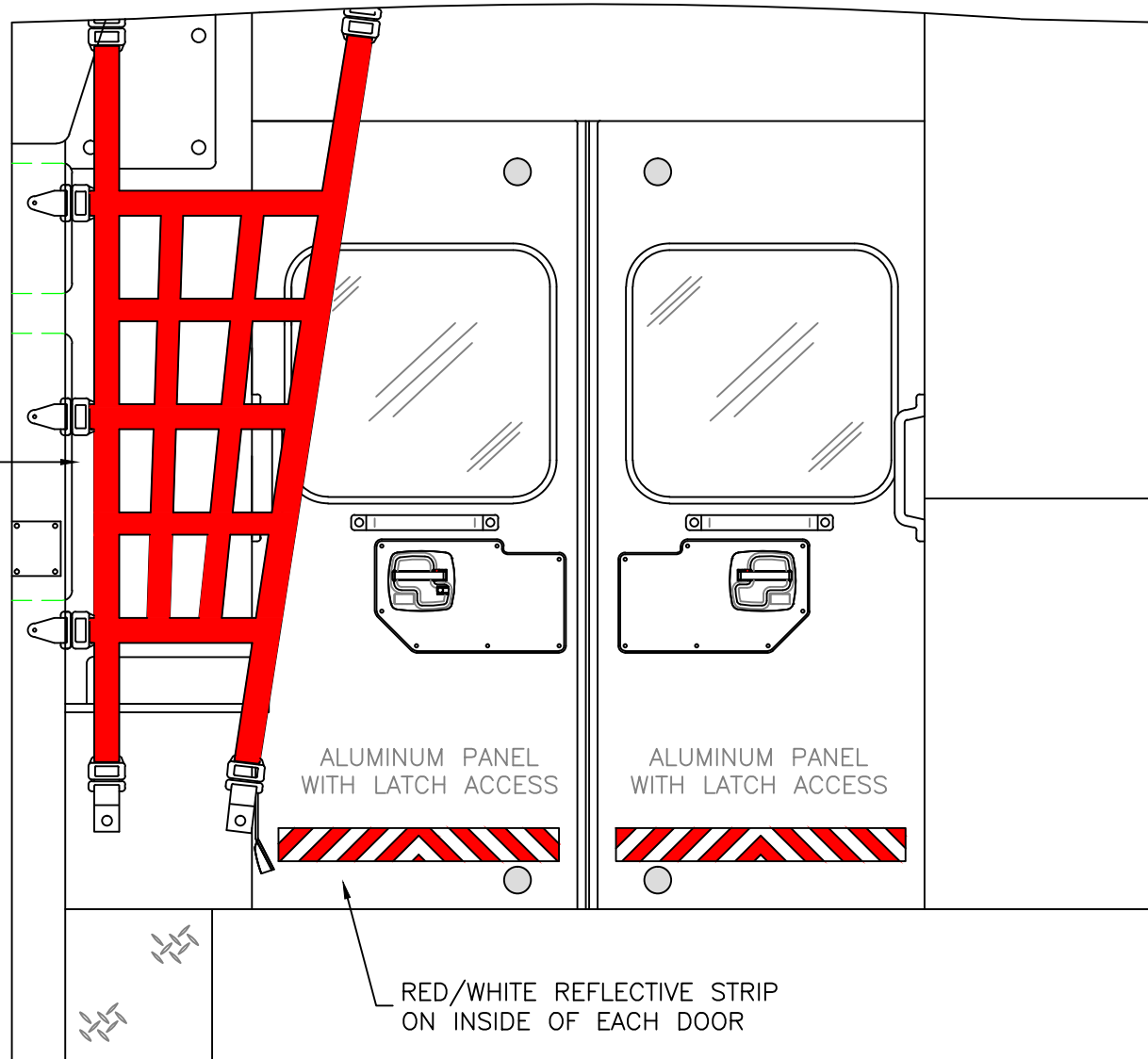

THIS DRAWING IS FOR REPRESENTATIONAL PURPOSES ONLY. DETAILS ARE CONCEPTUAL AND ARE SUBJECT TO CHANGE DURING DESIGN AND CONSTRUCTION DIMENSIONS ARE APPROXIMATE UNLESS NOTED OTHERWISE TO MEET A SPECIFIC CUSTOMER NEED.

BRAUN  
SIGNATURE SERIES



2020 REAR INTERIOR VIEW  
SIGNATURE SERIES

DATE:  
02-14-20  
DWG.  
AAB

REV.  
NR  
DRAWING NO.  
SIGNATURE-8

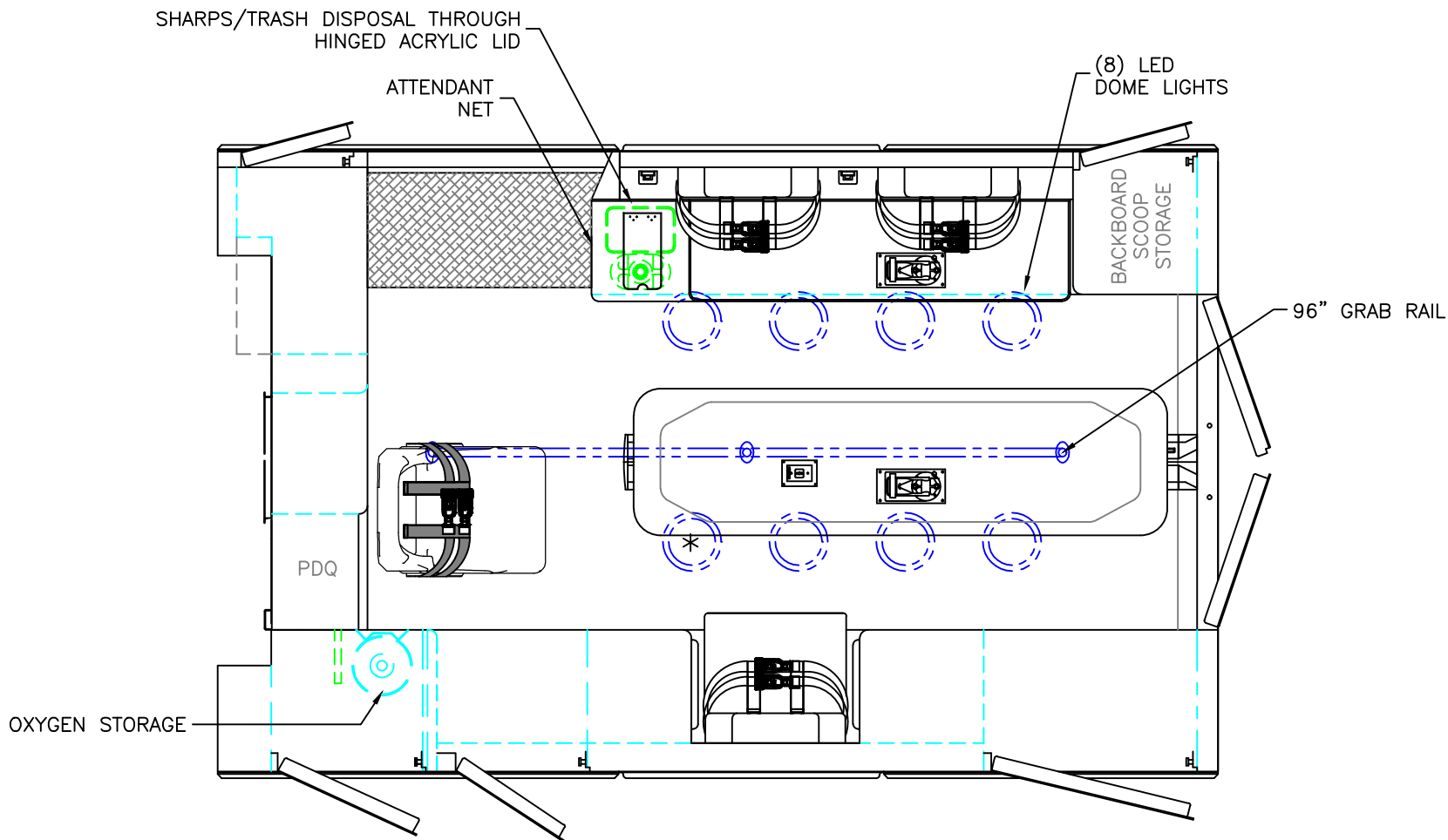

\* (1) ANTENNA BASE LOCATED OUTBOARD OF DOME LIGHT WITH COAX SERVICE LOOP

86" FERNO STAT-TRAC CENTER MOUNT COT HARDWARE

 = (2) RECESSED CAST PRODUCTS CEILING IV HANGERS

 = (1) CEILING OXYGEN OUTLET

HEAD ROOM = 68"  
 OVERALL WIDTH WITH RUB  
 RAILS & FENDERETTES = 95"  
 MODULE LENGTH = 150"

THIS DRAWING IS FOR REPRESENTATIONAL PURPOSES ONLY. DETAILS ARE CONCEPTUAL AND ARE SUBJECT TO CHANGE DURING DESIGN AND CONSTRUCTION DIMENSIONS ARE APPROXIMATE UNLESS NOTED OTHERWISE TO MEET A SPECIFIC CUSTOMER NEED.

BRAUN  
SIGNATURE SERIES



2020 FLOOR VIEW  
SIGNATURE SERIES

DATE: 02-14-20	
DWG. AAB	REV. NR

DRAWING NO.  
SIGNATURE-9  
WITH CPR SEAT

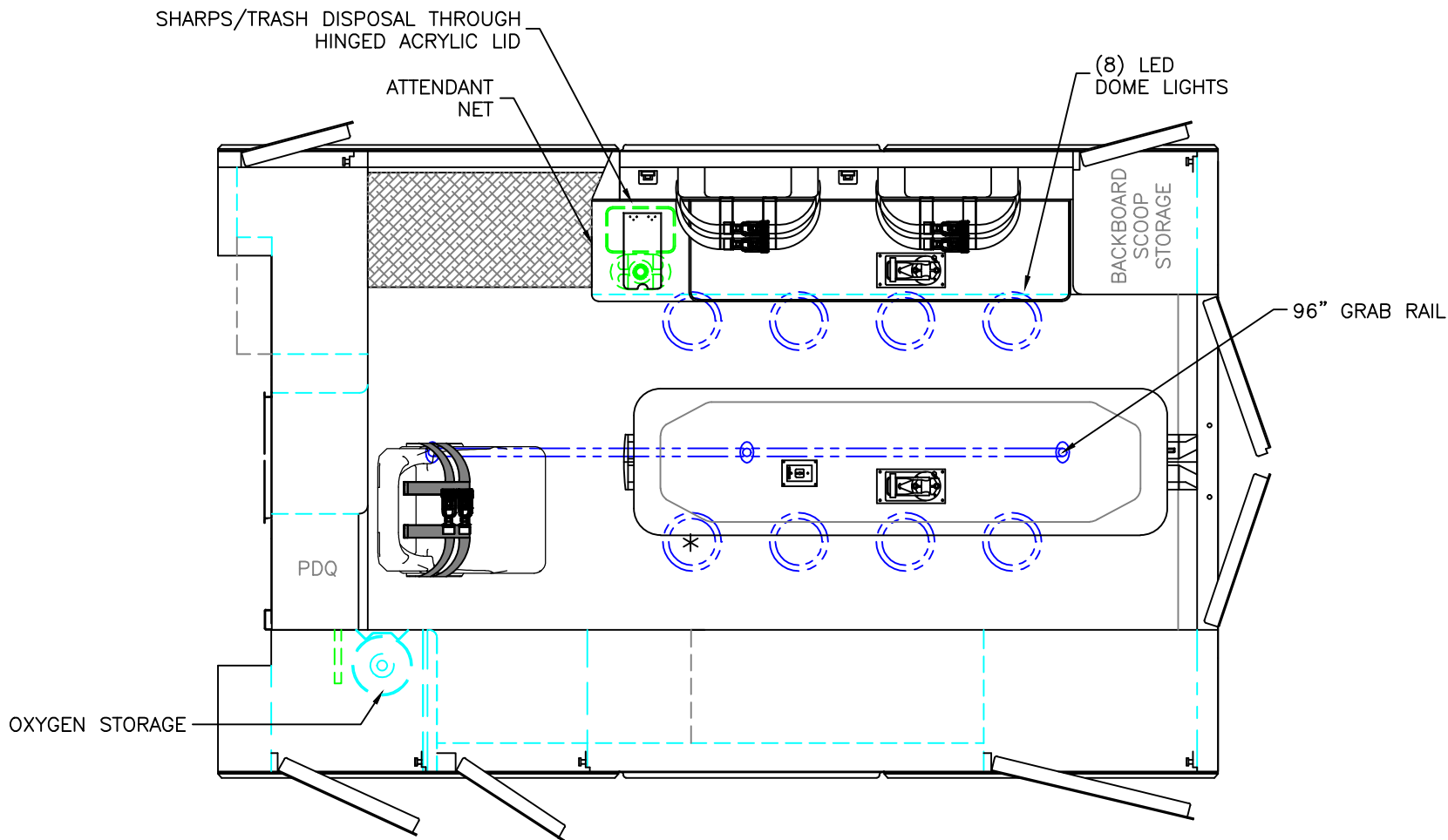

\* (1) ANTENNA BASE LOCATED OUTBOARD OF DOME LIGHT WITH COAX SERVICE LOOP

86" FERNO STAT-TRAC CENTER MOUNT COT HARDWARE

 = (2) RECESSED CAST PRODUCTS CEILING IV HANGERS

 = (1) CEILING OXYGEN OUTLET

HEAD ROOM = 68"  
 OVERALL WIDTH WITH RUB  
 RAILS & FENDERETTES = 95"  
 MODULE LENGTH = 150"

THIS DRAWING IS FOR REPRESENTATIONAL PURPOSES ONLY. DETAILS ARE CONCEPTUAL AND ARE SUBJECT TO CHANGE DURING DESIGN AND CONSTRUCTION DIMENSIONS ARE APPROXIMATE UNLESS NOTED OTHERWISE TO MEET A SPECIFIC CUSTOMER NEED.

BRAUN  
SIGNATURE SERIES



2020 FLOOR VIEW  
SIGNATURE SERIES

DATE: 02-14-20	
DWG. AAB	REV. NR

DRAWING NO. SIGNATURE-9 NO CPR SEAT
---